

# Power-Over-Ethernet Module

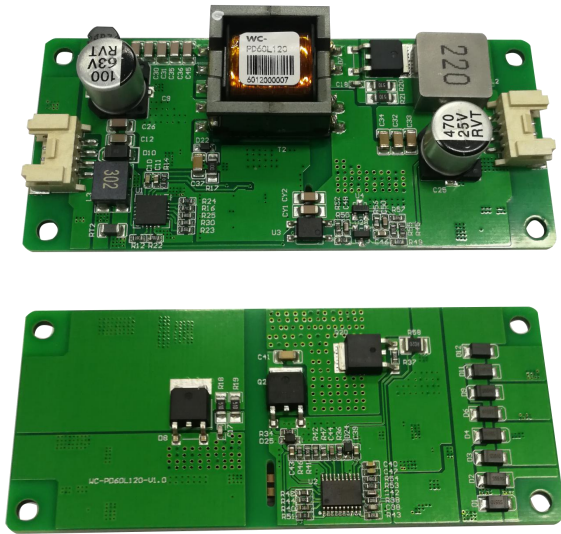

## 1. Product characteristics

- Compliance with IEEE802.3at&IEEE802.3bt standard.
- 48V~57V wide operating voltage range.
- Maximum output power up to 60W; Rated output: 12V/5A.
- The output ripple is less than 200 mV.
- Conversion efficiency can be as high as 90% (input: 48V output)12V@5A).
- Withovercurrent, short circuit, under voltage, surge andother excellent reliability and circuit protection.
- PCBA standard size: 90mm\*40mm\*12mm
- Input/Output: isolate 1500Vdc.
- High reliability: The design meets the 5 million hour average failure interval.

## 2. Scope of application

- Thin client
- POS system
- Digital signage
- Health care
- Lighting

## 3. describe

- The module is designed to extract power from conventional Class 5 to Class 6 Ethernet cable twisted pairs and meets the IEEE 802.3bt Power-Ethernet (PoE) standard. At the same time, the module allows the power supply category to select "Intermediate Overlap" and "End Overlap" power supply without distinguishing polarity.
- Based on the IEEE 802.3bt standard, this paper establishes information connection about the connection status, device type, power consumption level of the receiving device PD, and then applies power supply to port compatible devices based on PSE to power the PD through ethernet.
- This module DC/DC converter works in a wide input voltage range and low ripple low noise output. The DC/DC converter also has built-in output overload, output short circuit and overtemperature protection, and provides a 1500Vdc (input/output) electrical isolation.

### 4. Mechanical dimensions

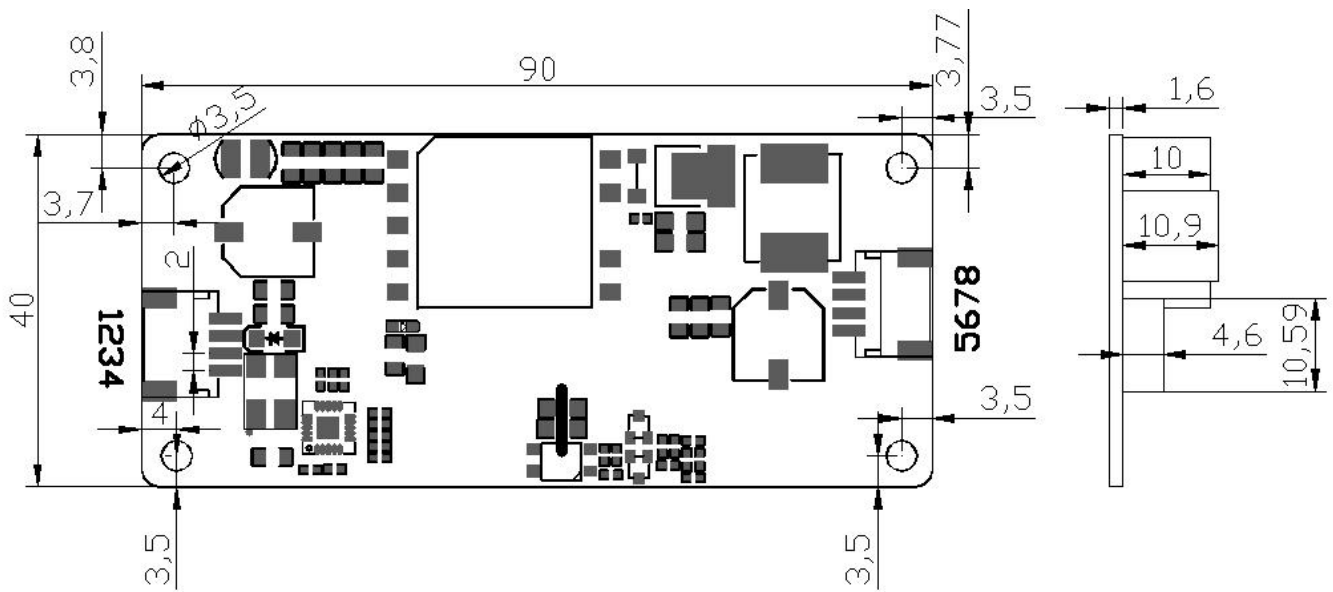

Company (mm)

All the above dimensional errors: ( $\pm 0.3$ )

### 5. pin definition

Pin	Name	describe
1	VA1	This input pin is connected with va2 and the central tap connected to the transformer, to pin 1 and pin 2 of RJ45 connector (Rx).
2	VA2	This input pin, together with va1 and, is connected to the transformer's central tap, to pins 3 and 6 of the RJ45 connector (TX).
3	VB1	This input pin is used with VB2 and connected to pins 4 and 5 of the RJ45 connector - it is not polarity sensitive.
4	VB2	This input pin is used with VB1 and connected to pins 7 and 8 of the RJ45 connector - it is not polarity sensitive.
5	Vout	DC output of the positive pole. This pin provides a positive regulation output
6	Vout	DC output of the positive pole. This pin provides a positive regulation output
7	GND	Negative DC output. This pin provides a negative regulation output
8	GND	Negative DC output. This pin provides a negative regulation output

## 5. Electrical characteristics

### 5.1 Absolute maximum rating parameter

No	parameter	Symbol	MIN	MAX	Units
1	DC Voltage	VCC	48	57	V
2	DC Voltage Surge 1ms	VSURGE	-0.6	80	V
3	ambient temperature	TS	-40	80	°C

\*Exceeding the above rating may cause permanent damage to the product. Functional operations under these conditions are not recommended.

### 5.2 Recommended working conditions

No	parameter	Symbol	MIN	TYP	MAX	Units
1	input voltage	VIN	42	48	57	V
2	Low Voltage Lock	VLOCK	37	-	-	V
3	working temperature	TOP	-40	25	80	°C

\*Applicable only to WC-PD60L120 maximum operating temperature.

### 5.3 DC Characteristic

No	parameter	Symbol	MIN	TYP	MAX	Units	Test Opinions
1	Standard Output Voltage	VDC	11.5	12.0	12.2	V	VIN=48v
2	Output Current (VIN=48V)	PWR	-	5	6	A	Wide voltage input 48-57V
3	Power adjustment rate	VLINE	-	0.1	-	%	@50% Load
4	Load Adjustment Rate	VLOAD	-	1	-	%	@VIN=48V
5	Ripple Output Noise	VRN	-	150	250	mVp-p	@Maximum Load
6	Minimum Load	RLOAD	10	-	-	mA	
7	Short circuit duration	TSC	-	-	∞	sec	
8	Efficiency (load 80%)	EFF	85	90	-	%	
9	Isolation Voltage (I/O)	VISO	-	-	1500	VPK	
10	temperature coefficient	Tc	-	0.02		%	Per °C
11	efficiency	Tr	-	150	250	ms	输入=48V 输出=max

1: Typical number is 25 C, nominal voltage is 48V, for auxiliary design only.

2: Output ripple and noise can be reduced by an external filter, see the application instructions.

3: If operated under the specified minimum load, the module emits audible noise and may cause PSE malfunction.

## 6. Functional Description

### 6.1 input

WC-PD60L120 input end with bridge stack ensures input polarity protection, user can choose the connection mode as needed.

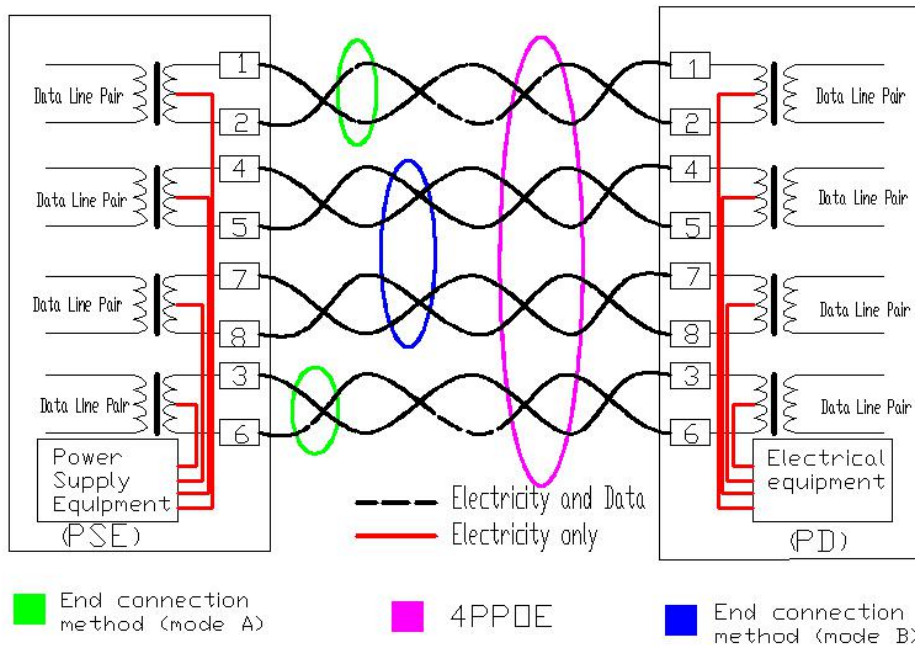

### 6.2 PD Signature

When the module is connected to the cable, it will automatically provide the Power Device (PD) signature to the PSE when needed. The PSE recognizes that the PD is connected to that line and provides power

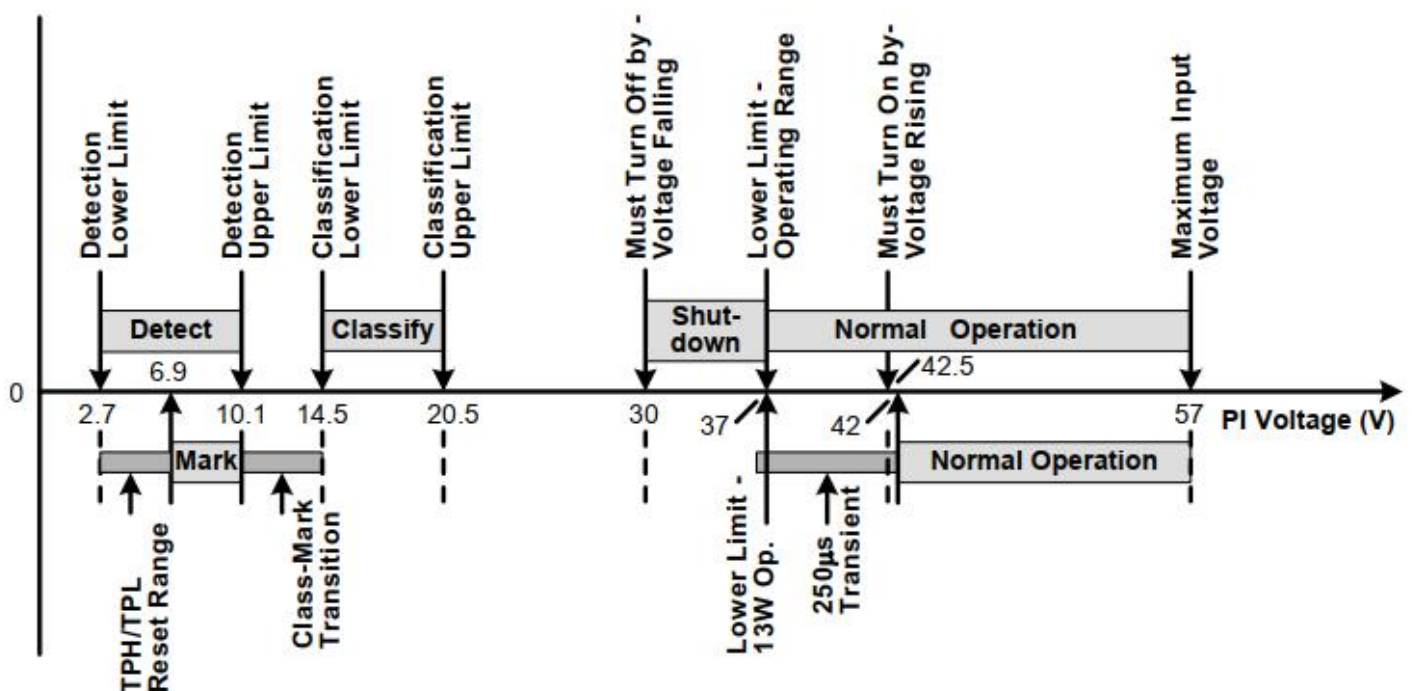

### 6.3 Power Classification

WC-PD60L120 uses IEEE802.3bt standard and runs with Class 7 (60W) power rating by default.

Define criteria	Cable requirements	Grading parameters	Power Supply Characteristics
IEEE802.3at (PoE)	CAT5 cable or CAT6 cable	Maximum power required for Class4 devices is 13W~25.5W	The DC voltage ranges from 42 to 57V, with a typical value of 48V.  Typical operating current is 10~600mA; typical output power: 30W;  Class4 rating supported by electrical equipment
IEEE802.3bt (PoE++)	CAT5 cable or CAT6 cable	Maximum power required for Class5 devices is 40W	The DC voltage ranges from 48 to 57V, with a typical value of 52V.  Typical operating current is 10~1300mA; typical output power: 62W;
		The maximum power required for Class6 devices is 51W	
		The maximum power required for Class7 devices is 62W	
		The maximum power required for Class8 devices is 71W	

### 7. Typical schematic diagram

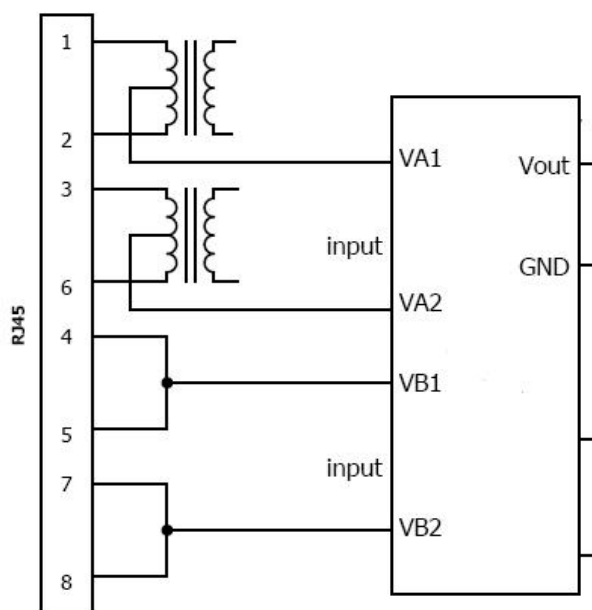

## 8. PoE Product naming rules

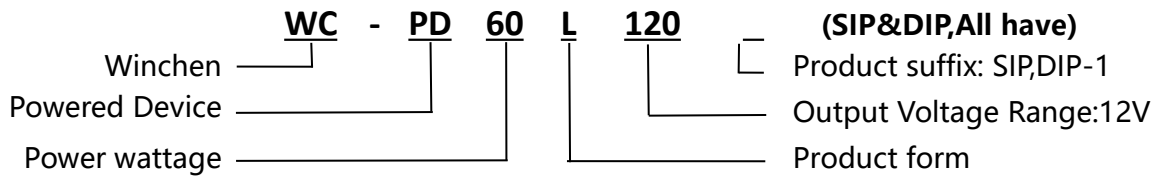

## 9. Typical applications

This module is used in PSE network cable to convert electric energy to DC-DC to the required voltage of equipment without affecting data signal transmission. It conforms to IEEE 802.3bt standard and is used by all equipment terminals

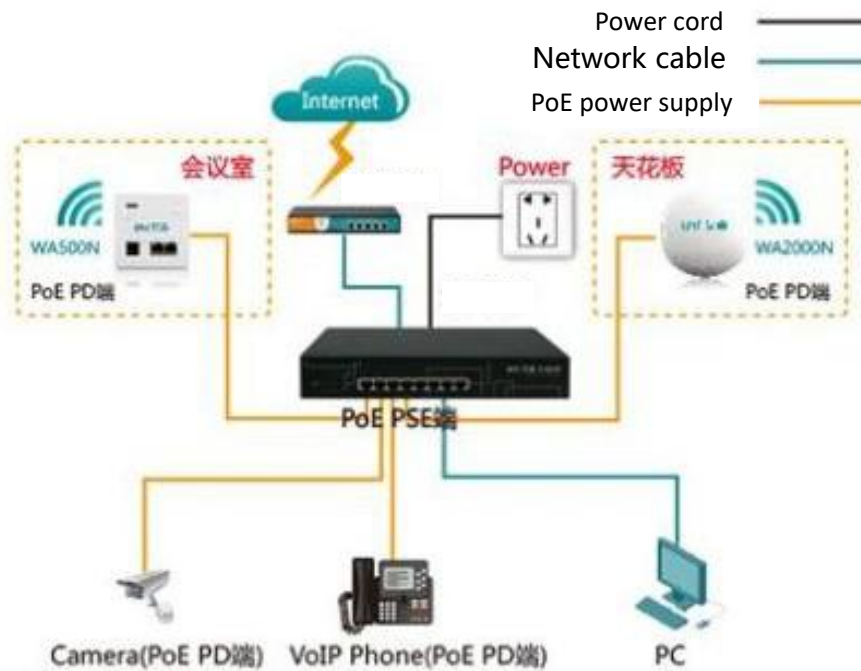

# 10. Test waveform diagram

Typical features: Vout=12

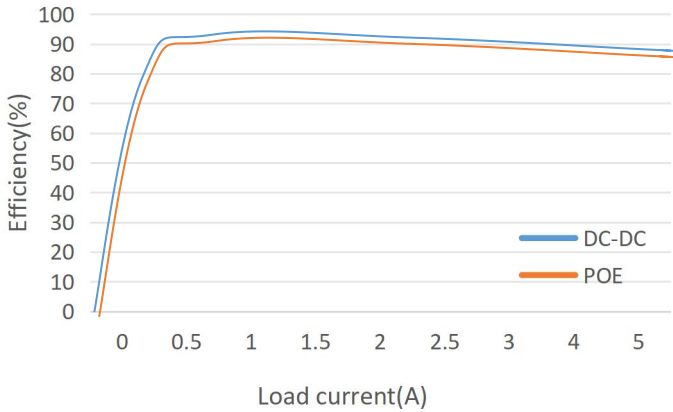
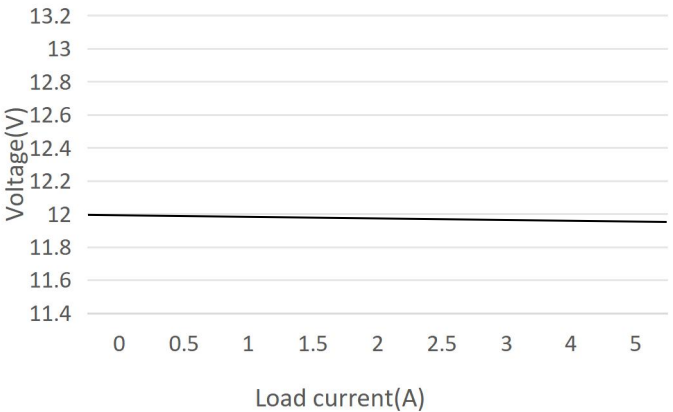
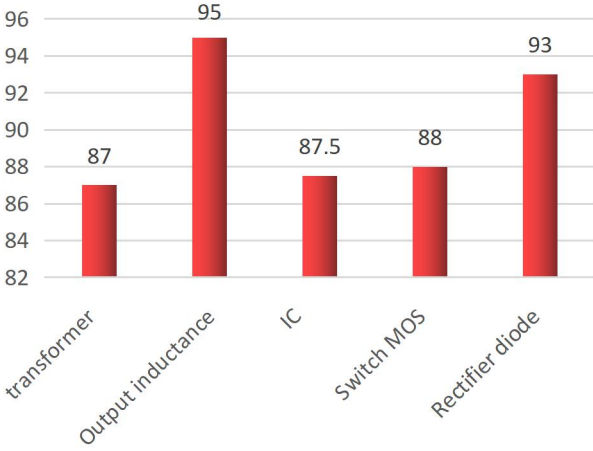
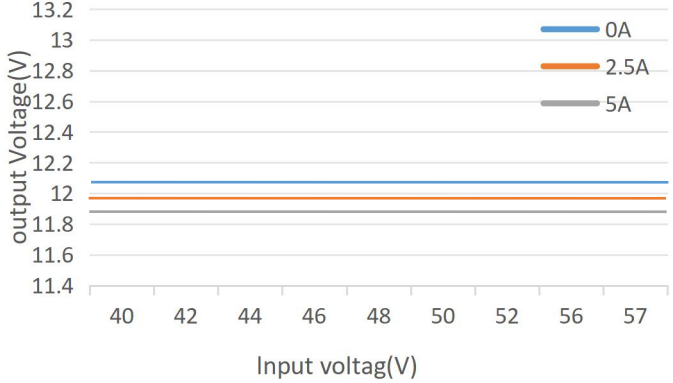
 <p>Efficiency(%)</p> <p>Load current(A)</p> <p>DC-DC</p> <p>POE</p>	 <p>Voltage(V)</p> <p>Load current(A)</p>
<p>Efficiency (Vout = 12 V)</p>	<p>Output voltage (input 48V)</p>
 <p>transformer</p> <p>Output inductance</p> <p>IC</p> <p>Switch MOS</p> <p>Rectifier diode</p>	 <p>output Voltage(V)</p> <p>Input voltage(V)</p> <p>0A</p> <p>2.5A</p> <p>5A</p>
<p>Maximum temperature of components Conditions (ambient temperature: 25 °C; output power: 12V / 5A; frequency: 3H)</p>	<p>Input voltage &amp; output voltage</p>

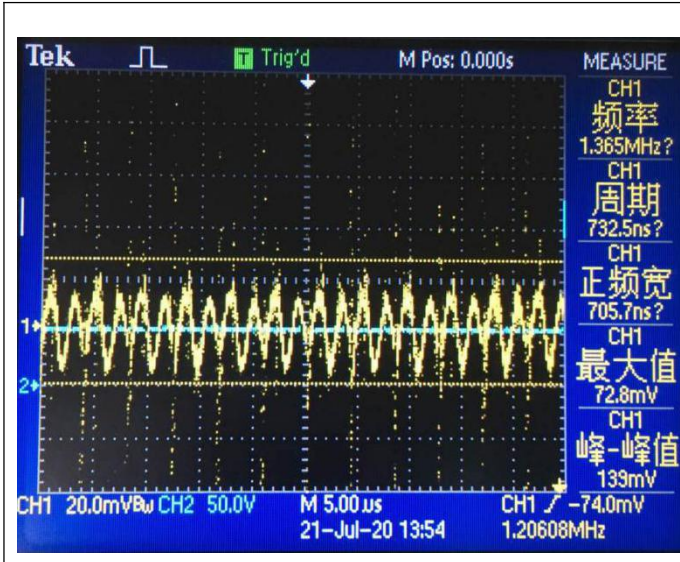

Noise (VIN = 42V, IO = 5A, 5 ~ 20MHz bandwidth)

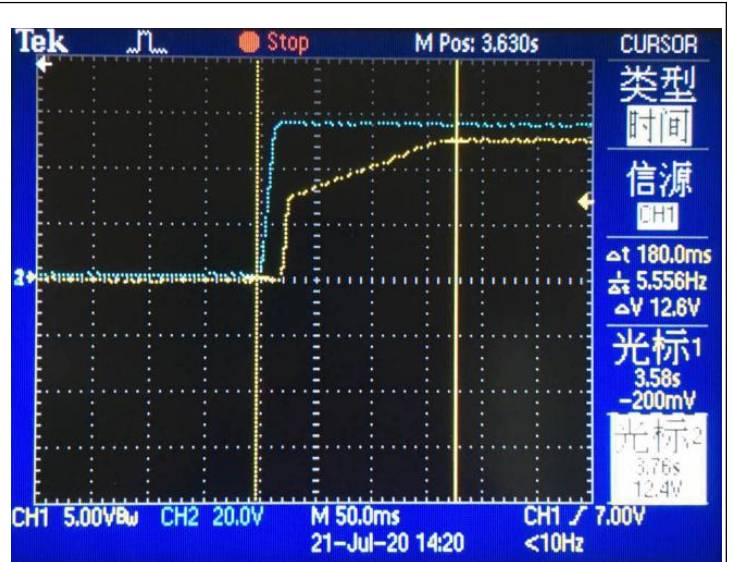

Output response & load (12V / 0.02A)

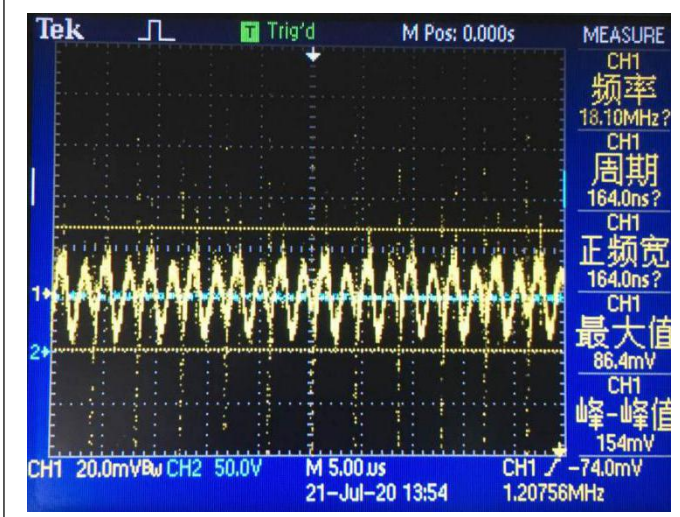

Noise (VIN = 48V, IO = 5A, 5 ~ 20MHz bandwidth)

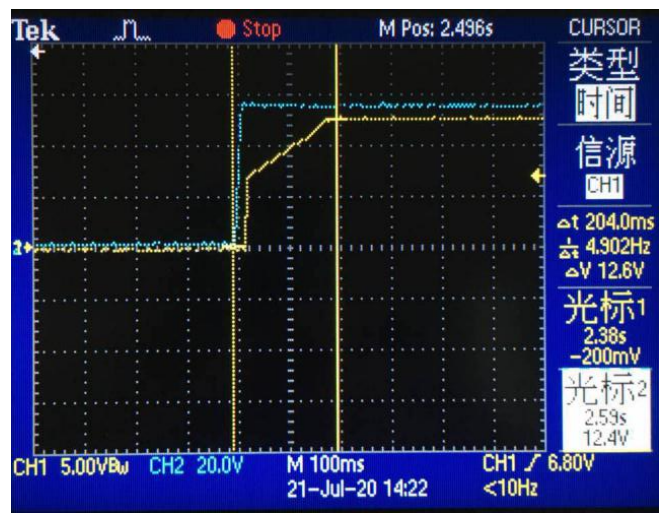

Output response & load (12V / 2.5A)

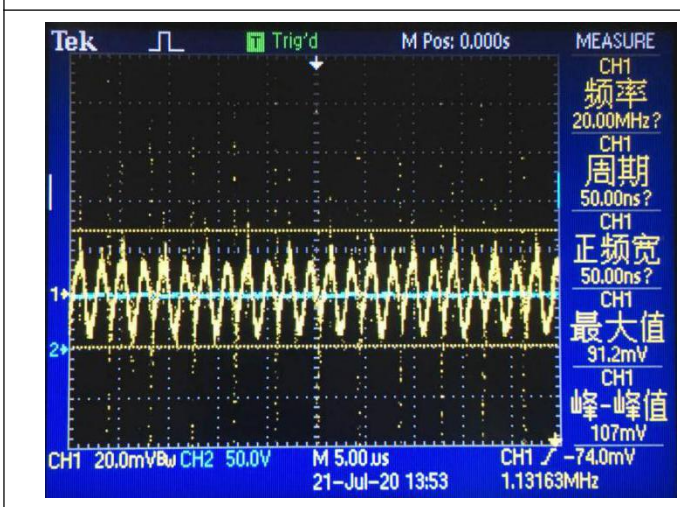

Noise (VIN = 57V, IO = 5A, 5 ~ 20MHz bandwidth)

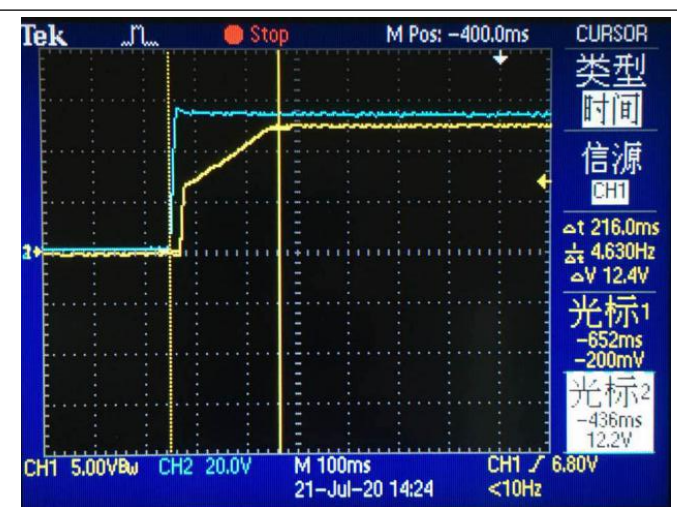

Output response & load (12V / 5A)